

# Classrooms & Meeting Rooms

This is an unofficial guide to GSE classrooms and meeting rooms that have been used for classes.

**AV Equipment** All classrooms have automated lecture capture unless otherwise noted. As a rule, the smallest meeting rooms do not have lecture capture

**In-Room Features** All classrooms and meeting rooms should have wall-mounted blackboards or whiteboards unless otherwise noted.

**Room Setups** Operations does not have capacity to reset classrooms between courses.

- If a classroom setup change is requested, we will try to find an accommodation that is acceptable to all courses using the room that day in order to avoid midday changes.
- If a midday setup change is necessary, we will need a minimum of one hour before and after the class to effect the changes.
- If a course or event chooses to rearrange the furniture in a classroom, they are responsible for restoring the furniture to its original setup.

**Food and Drink** We ask that all food and drink served in and around classrooms be provided by Rebecca's Café. However, it is acceptable to bring other food and non-alcoholic beverages to most classrooms and meeting rooms if the total value of the food and beverage is less than \$100.

- Askwith is an exception: as an event space, any food or beverage served to courses using Askwith should be provided by Rebecca's Café, regardless of value. Food and drink should not be brought inside of Askwith. (Water bottles are acceptable.)
- If food is served in a classroom, the event planners are responsible for removing any leftovers after the event.

# Gutman Library

## Gutman 302

- 59 seats
- 40 chairs at tables and 19 tablet chairs
- Movable seats
- No windows

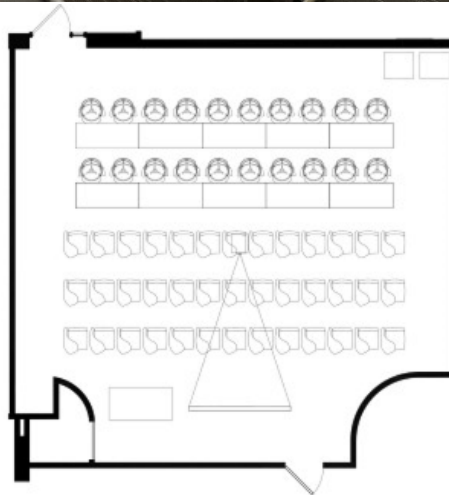

## Gutman 302 & 303

- Setup to the right with 78 tablet chairs and 40 chairs at tables
- 118 seats
- 80 chairs and 38 tablet chairs
- Gutman 302 and 303 can be combined into different arrangements.
- The process is not easy, so it best to leave the rooms combined for the whole day if that arrangement will be needed.

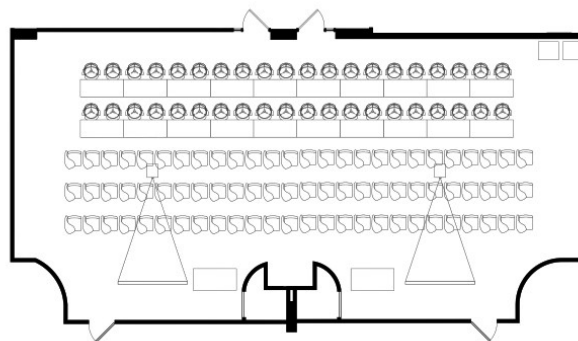

**Gutman 303**

- 59 seats
- 40 chairs at tables and 19 tablet chairs
- No windows
- Movable furniture

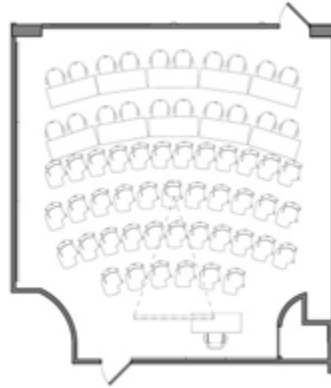
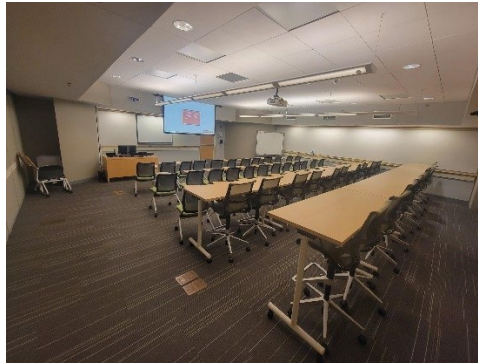

**Gutman 305**

- 49 chairs in rows
- No external windows. The room has a frosted glass wall that provides some natural light.
- Movable furniture
- Zoom room tech available

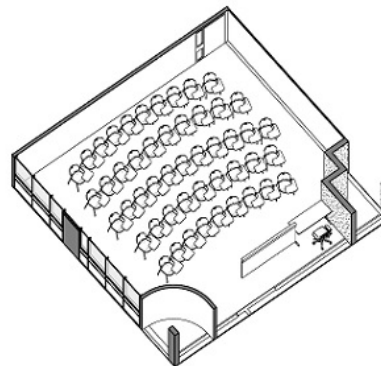

### Gutman 350

- 14 chairs
- No lecture captures
- External windows
- Table does not move
- *Gutman 437 is virtually identical, it is not technically a classroom but can be used as such*

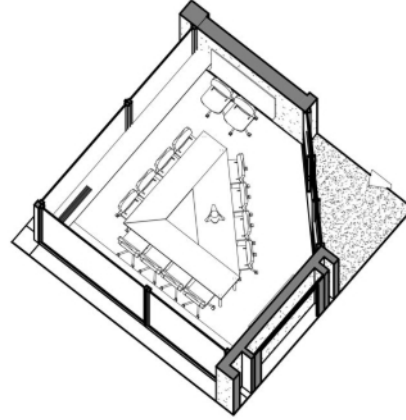

### Gutman 404

- 18 chairs total
- Gutman 404 *does* have lecture capture.
- No external windows
- Open Square or boardroom setup

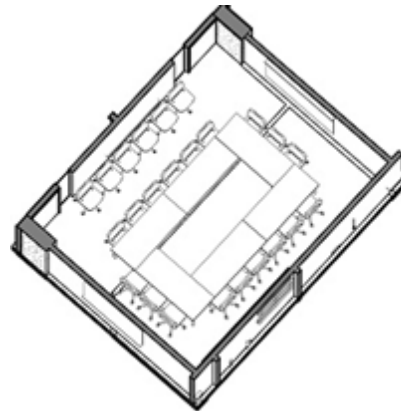

### Gutman 440

- 33 chairs in rows
- No external windows
- Movable furniture

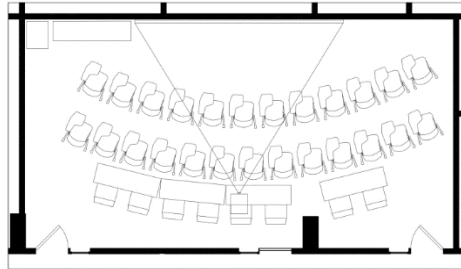

## Larsen Hall

### Larsen 106

- 81 chairs at tables
- No external windows. The room has a frosted glass wall that provides some natural light.
- Tables do not move

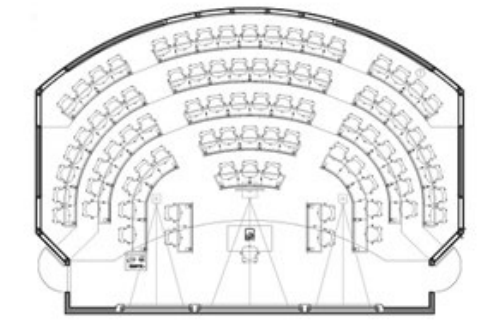

### Larsen 203

- 50 chairs at tables
- No external windows
- Tables do not move

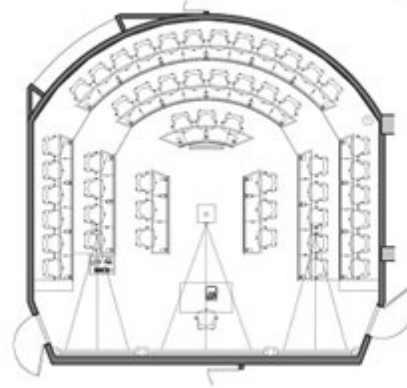

### Larsen 214

- 10 pairs of tables with 60 chairs
- Does not have lecture capture
- External windows
- Movable furniture; this room can be reconfigured in several ways).
- Two pillars in room may interfere with view when at full capacity
- No wall-mounted whiteboards; mobile boards can be brought in upon request

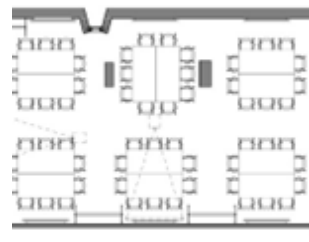

### Larsen 402

- 12 chairs around table
- 6 tablet chairs against walls
- No lecture capture
- External windows
- Tables do not move

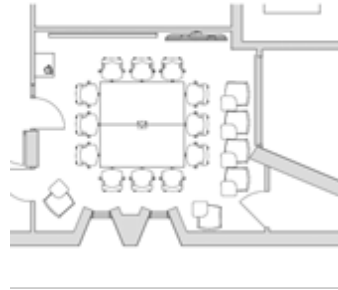

### Larsen 513

- 12 chairs around table
- No lecture capture
- No external windows
- Table does not move

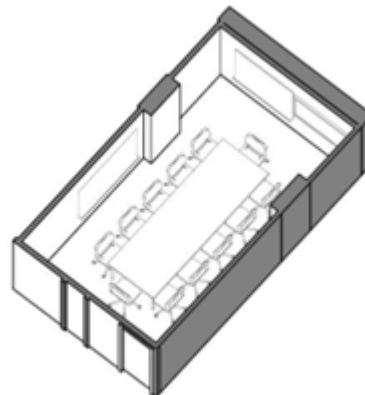
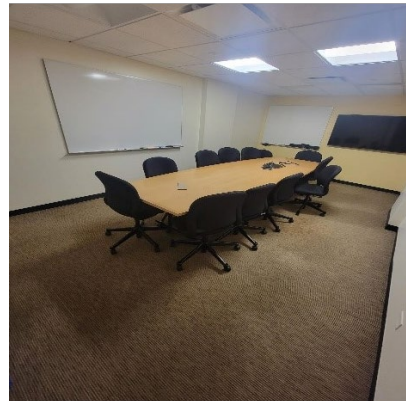

### Larsen 615

- 16 chairs around table; 3 tablet chairs against wall
- No lecture capture
- External windows
- Tables do not move

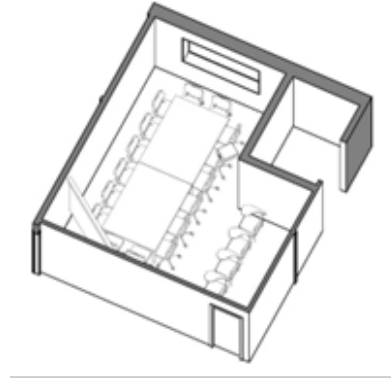

### Larsen 709

- 10 chairs around table
- Additional chairs sometimes in room
- No lecture capture
- No AV equipment
- No windows
- Table does not move

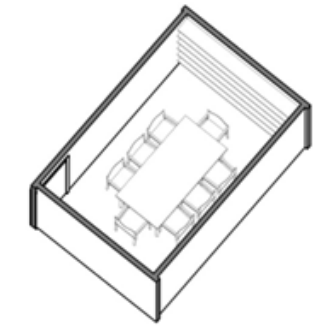

### Larsen 710

- 8 chairs around table
- At least 10 additional chairs against walls
- Limited AV equipment
- No lecture capture
- External windows
- Semi-private, has an on-suite kitchen space

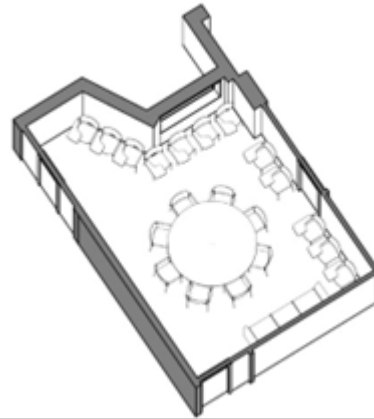

### Larsen G01

- 42 chairs in rows
- External windows
- Movable furniture

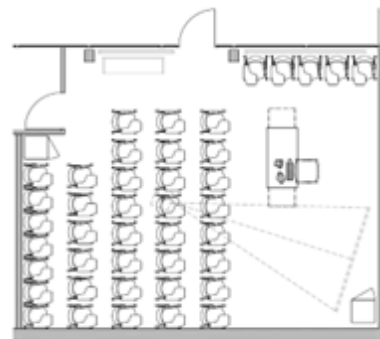
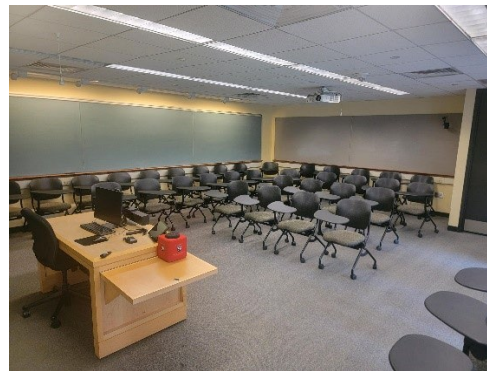

### Larsen G06

- 35 chairs in U-shape
- External windows
- Movable furniture

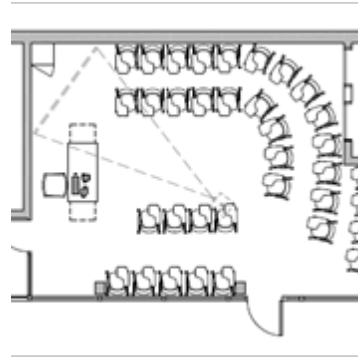

### Larsen G08

- 114 seats
- Tiered seating
- There is a small elevator to provide access to speaker's level.
- No external windows.
- Tables do not move

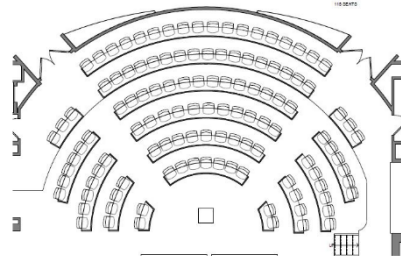

# Longfellow Hall

## Askwith Hall (Longfellow 116)

- 268 fixed seats with small writing surfaces that can be folded away.
- External windows
- Furniture does not move
- AV equipment is complex; IT support is recommended

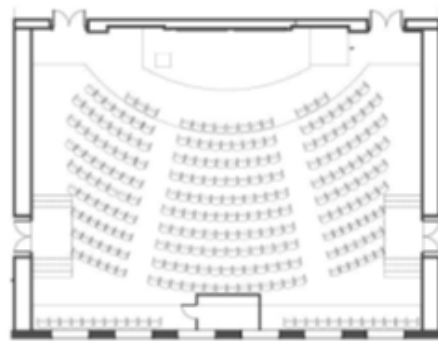

## Longfellow 207

- 16 chairs around table
- 14 chairs against walls
- No automated lecture capture; room does have recording equipment that requires the assistance of an IT staff member
- External windows
- Table does not move



**Longfellow 207**

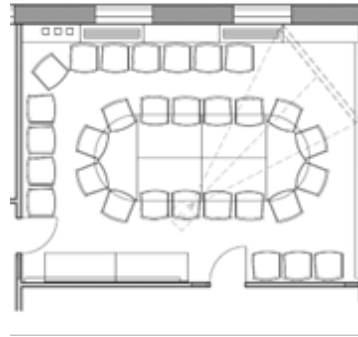

**Longfellow 228**

- 42 tablet chairs in curving rows
- External windows
- Movable furniture

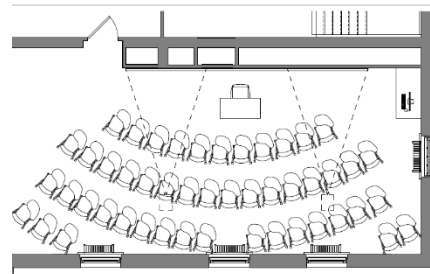

**Longfellow 229**

- 20 tablet chairs
- 16 chairs at tables
- External windows
- Movable furniture
- Can be reconfigured as a boardroom table for 20 (if there is enough time before and after class).



### Longfellow 229

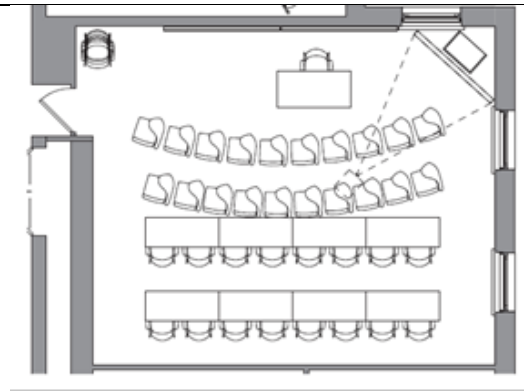

### Longfellow 319 - Standard

- 32 node chairs and 28 chairs at tables.
- Seating can be increased to 70.
- The walls can be used as whiteboards.
- AV equipment is in a closet.
- Small-group setups are also possible.
- External windows
- Movable furniture

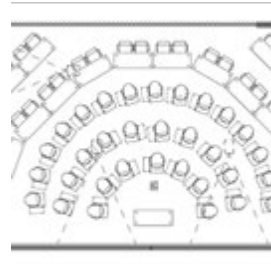

### Longfellow 319/320 Combined - Standard

- 36 node chairs & 56 chairs at tables.
- Seating can be increased to 140.
- AV equipment is complex and IT support is recommended.
- It takes at least half an hour to open or close the wall between Longfellow 319 and 320.
- Small-group setups are also possible.
- Walls can be used as whiteboards.

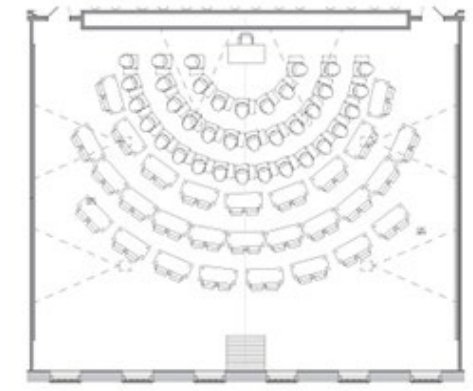

**Longfellow 320 - Standard**

- 32 node chairs and 28 chairs at tables.
- Seating can be increased to 70.
- The walls can be used as whiteboards.
- AV equipment is in a closet.
- Small-group setups are also possible.
- External windows
- Movable furniture

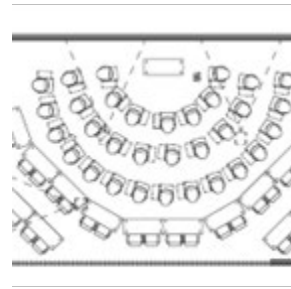

**Longfellow 319 or 320 – Small Groups**

- 32 node chairs and 28 chairs in small groups.
- The walls can be used as whiteboards.
- AV equipment is in a closet.
- External windows
- Movable furniture

